

Uniden®

OWNER'S MANUAL



2-LINE CORDLESS WITH
CALLER ID/CALL WAITING

**QUICK & EASY
SET-UP GUIDE**

SEE QUICK
REFERENCE
GUIDE SECTION

EXI 3226

EASILY REGISTER THIS
PRODUCT ONLINE AT
WWW.UNIDEN.COM

Step 1 Checking the Package Contents

Make sure you have received the following items in the package. If any of these items are missing or damaged, contact the Uniden Parts Department.

- Base unit
- Handset
- AC adapter
- Rechargeable battery
- Telephone cord
- Beltclip
- This Owner's Manual
- Other Printed Material

Uniden Parts Department at (800) 554-3988
Hours: M-F 8:00 a.m. to 5:00 p.m. CST.
We can also be reached on the web at
www.uniden.com

Step 2 Install and Charge the Handset Battery

TO INSTALL THE HANDSET BATTERY

- Remove the cover.
 - Connect the battery pack connector with the correct polarity.
 - Replace the cover.
 - Plug the AC adapter cord into the base unit and then into a 120V AC outlet.
- 

www.uniden.com

E

Place the handset on the base and charge continuously for 15 - 20 hours before using the phone.

Step 3 Connect to Phone Line

When the handset battery pack is fully charged, after 15-20 hours of charging, plug the telephone cord into the base unit and then into a telephone wall jack.

Your phone is set for tone dialing. If your local network requires pulse dialing, please see "Choosing the dialing mode" on page 16.

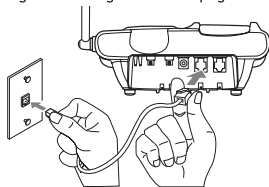

Step 4 Setting Display Options

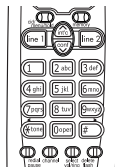

Note: Three Caller ID options are available: AutoTalk, Caller ID on Call Waiting (CIDCW), and Area Code.

TO CHANGE CALLER ID OPTIONS

- Press and hold *cid/menu/hold*.
- Select "Line 1" or "Line 2" with the $\wedge/int'c$ or $\vee/conf$, then press $\#/>$.
- Use $\wedge/int'c$ and $\vee/conf$ to move the cursor to an option.
- Press *select/vol/ring* to change the option setting.
- Press *cid/menu/hold* and return the handset to the base.

TO CHOOSE THE LANGUAGE

- Press and hold *cid/menu/hold*.
- Use $\wedge/int'c$ or $\vee/conf$ to move the cursor to language.
- Press *select/vol/ring* to select Eng (English) or Fr. (French).
- Press *cid/menu/hold* and return the handset to the base.

OPTIONS INCLUDE

- | | |
|---|--------------|
| A Auto Talk | On/Off |
| B CIDCW (Caller id/call waiting) | On/Off |
| C Area Code | Enter/Remove |
| D Language | Eng/Fr |

Contents

Quick Reference Guide	3	Using your EXI3226 intercom	29
Welcome/Features	5	Transferring calls	30
Controls and Functions	6	Memory Features	
Getting Started		Storing phone numbers and names	31
Setting up the phone	8	Steps for entering names and special characters	33
Mounting the base unit on a wall	13	Making calls with memory dialing	34
Setting menu options	15	Chain dialing	35
Basics		Editing a stored name and/or phone number	35
Making and receiving calls	19	Erasing a stored name and phone number	37
Adjusting the ringer and earpiece/speaker volume	20	Caller ID Features	
Redial	21	Caller ID	39
Tone dialing switch-over	21	When the telephone rings	39
Traveling out-of-range	21	Viewing the Caller ID message list	40
Selecting a different channel	22	Using the Caller ID list	41
Using the page feature	22	Deleting information from the Caller ID list	43
Flash and call waiting	22	Using CIDCW (Caller ID on Call Waiting)	44
Using the speakerphone	23	Additional Information	
Answering a call from the base	23	Changing the digital security code	45
Answering a call from the handset	23	Installing the beltclip	46
Making a call from the base	24	Headset installation	46
Making a call from the handset	24	Note on power sources	47
Placing a call on hold	25	Maintenance	47
Using the speakerphone mute feature	25	Troubleshooting	48
2-Line Features		General information	50
2-Line operation	26	Precautions and Warranty	51
3-way conferencing	27	Industrial Canada Information	53
4-way conferencing	28	Index	54

Welcome

Congratulations on your purchase of the Uniden EXI3226 cordless telephone. This phone is designed and engineered to exacting standards for reliability, long life and outstanding performance.

Note: Some illustrations in this manual may differ from the actual unit for explanation purposes. The color of your cordless phone may vary.



As ENERGY STAR® Partner, Uniden has determined that this product or product models meets the ENERGY STAR® guide lines for energy efficiency. ENERGY STAR® is a U.S. registered mark.

Features

- 2.4GHz Extended Range
- 2-Line Operation with Intercom
- Caller ID and Call Waiting Caller ID
- 80 Number Caller ID Memory
- 40 Number Memory (including the ten at base unit)
- 32 Digit Redial
- Bi-lingual Display Option
- Flash and Pause
- Tone/Pulse Dialing
- 14 Day Standby Battery Life
- 7 Hour Talk Time
- Handset Earpiece and Ringer Volume Control
- Speakerphone
- 3-Way and 4-Way Conference Operation

Be sure to visit our web site: www.uniden.com

Uniden® is a registered trademark of Uniden America Corporation.

AutoTalk, AutoStandby, UltraClear Plus, Random Code, and AutoSecure are trademarks of Uniden America Corporation.

Controls and Functions

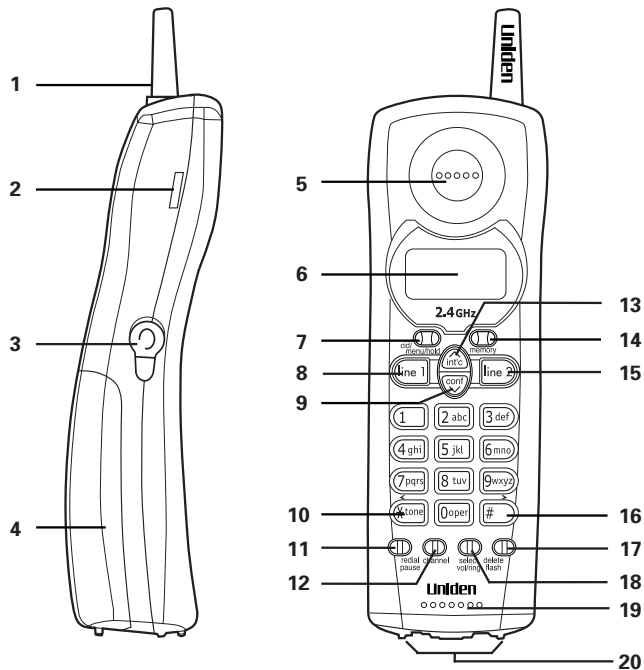

1. Handset Antenna
2. Beltclip Holes
3. Optional Headset Jack
4. Handset Battery Compartment
5. Handset Earpiece
6. LCD Display
7. Cid/menu/hold Key
8. Line 1 Key
9. ∨(down)/conf Key
10. */tone/< (left cursor) Key
11. Redial/pause Key
12. Channel Key
13. 2.4GHz
14. Memory Key
15. Line 2 Key
16. #/> (right cursor) Key
17. Delete/flash Key
18. Select/vol/ring Key
19. Handset Microphone and Ringer Speaker
20. Handset Charging Contacts

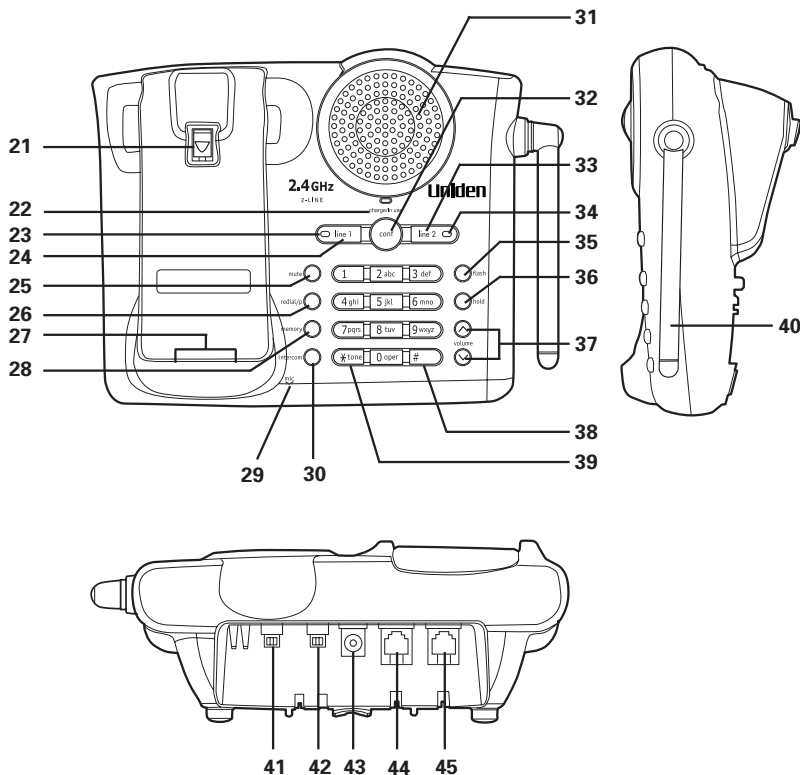

- 21. Handset Retainer Clip
- 22. Charge/In use LED
- 23. Line 1 status LED
- 24. Line 1 Key
- 25. Mute Key
- 26. Redial/p (pause) Key
- 27. Base Charging Contacts
- 28. Memory Key
- 29. Base Microphone
- 30. Intercom Key
- 31. Base Speaker
- 32. Conf (conference) Key
- 33. Line 2 Key
- 34. Line 2 status LED
- 35. Flash Key
- 36. Hold Key
- 37. Volume ^ (up)/∨ (down) Keys
- 38. # Key
- 39. */tone Key
- 40. Base Antenna
- 41. Ring Volume Switch (2nd Line)
- 42. Ring Volume Switch (1st Line)
- 43. DC Power Input
- 44. Phone Jack (2nd Line)
- 45. Phone Jack (1- and 2- Line)



If your home has specially wired alarm equipment connected to the telephone line, be sure that installing the system does not disable your alarm equipment.

If you have questions about what will disable your alarm equipment, contact your telephone company or a qualified installer.

Setting up the Phone

Do the following steps:

- A. Choose the best location
- B. Install the rechargeable battery pack into the handset.
- C. Connect the base unit
- D. Choosing the dialing mode

A. Choose the best location

Before choosing a location for your new phone, read the **INSTALLATION CONSIDERATIONS** included in the **PRECAUTIONS AND IMPORTANT SAFETY INSTRUCTIONS**. Here are some important guidelines you should consider:

Avoid heat sources, such as radiators, air ducts, and sunlight

Avoid television sets and other electronic equipment

Choose a central location

Avoid noise sources such as a window by a street with heavy traffic

Avoid microwave ovens

Avoid excessive moisture, extremely low temperatures, dust, mechanical vibration, or shock

Avoid personal computers

Avoid other cordless telephones

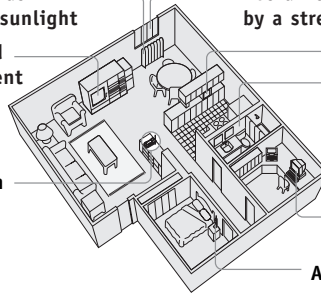

- The location should be close to both a phone jack and a continuous power outlet which is not switchable.
- Keep the base and handset away from sources of electrical noise such as motors, microwave ovens, and fluorescent lighting.
- Be sure there is sufficient space to raise the base antenna to a vertical position.
- The base can be placed on a desk, tabletop, or mounted on a standard wall plate.
- If your second phone line has a separate modular jack, place your phone so you can access both jacks.

B. Install the rechargeable battery pack into the handset

The handset is powered by a rechargeable battery pack. The battery recharges automatically when the handset is placed on the base unit.

Charge the handset battery pack for at least 15-20 hours before using your new cordless telephone for the first time!

To maximize the charge capacity of your battery pack, **DO NOT** plug the telephone cord into the base unit and wall jack until the battery is fully charged.

- 1) Press down on the handset battery case cover (use the finger indentation for a better grip) and slide the cover downward to remove.
- 2) Plug the battery pack connector (red & black wires) into the small, black jack inside the battery compartment. (The connector notches fit into the grooves of the jack only one-way.) Match the wire colors to the polarity label in the battery compartment, connect the battery and listen for a click to insure connection.
- 3) Make certain you have made a good connection by slightly pulling on the battery wires to insure that there is a secure connection. If the battery connector is not securely connected, the handset will not charge properly.

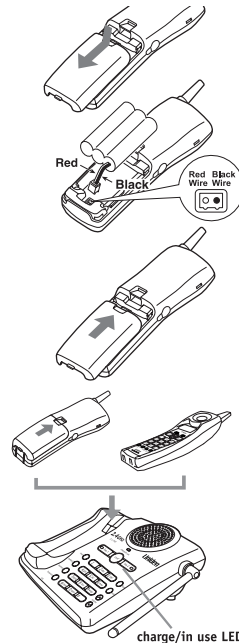

Use only the Uniden (BT-905) rechargeable battery pack supplied with your cordless telephone.

Replacement batteries are also available through the Uniden Parts Department at (800)554-3988, Monday through Friday from 8:00 a.m. to 5:00 p.m. or online at www.uniden.com.



Even when the battery pack is not being used, it will gradually discharge over a long period of time. For optimum performance, be sure to return the handset to the base unit after each telephone call.

• **Talk Mode-**

The handset is off the base and **line 1** or **line 2** has been pressed enabling a dial tone.

• **Standby Mode-**

The handset is not in use, off the base and **line 1** or **line 2** has not been pressed. A dial tone is not present.

Battery use time (per charge)

From fully charged

- Up to seven hours continuous use during talk mode.
- Up to fourteen days when the handset is in the standby mode.

Low battery alert

When the battery pack is very low and needs to be charged, the phone is programmed to eliminate functions in order to save power. If the phone is not in use, "Low Battery" appears on the LCD and none of the keys will operate.

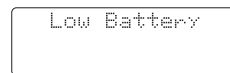

If the phone is in use, "Low Battery" flashes and the handset beeps. Complete your conversation as quickly as possible and return the handset to the base unit for charging.



The handset memory backup can hold Caller ID Memory, Memory Dial, and all settings stored in memory even if the battery pack is completely discharged.

Cleaning the charging contacts

To maintain a good charge, it is important to clean the charging contacts on both the handset and base unit once a month. Use a dry cloth or pencil eraser to clean. If the contacts become very dirty, using water only, dampen a cloth to clean the charging contacts. Then make sure to go back over the charging contacts with a dry cloth before returning the handset to the base to charge.

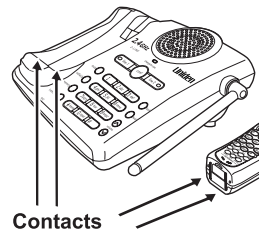

C. Connect the base unit

- 1) Connect the AC adapter to the **DC IN 9V** jack and to a standard 120V AC wall outlet.
- 2) Set the base on a desk or tabletop, and place the handset on the base unit as shown. Remove the beltclip, if attached for face up charging. (For wall mounting, see "Mounting the Base Unit on a Wall", on page 13 and 14).
- 3) Raise the antenna to a vertical position.
- 4) Make sure the **charge/in use** LED is illuminated. If the LED is not illuminated, check to see that the AC adapter is plugged in and the handset makes good contact with the base charging contacts.

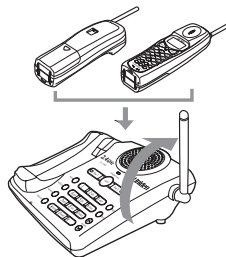
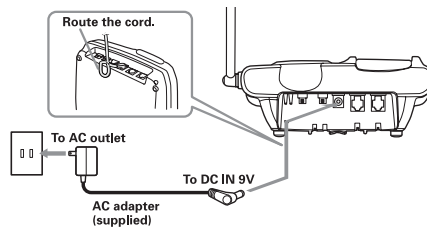

- Use only the supplied AD-314 AC adapter. Do not use any other AC adapter.
- Place the power cord so that it does not create a trip hazard or where it could become chafed and create a fire or electrical hazard.



The handset can be placed face up or face down on the base for charging.



- Connect the AC adapter to a continuous power supply.
- Place the base unit close to the AC outlet so that you can unplug the AC adapter easily.



For 2 line subscriptions,

- If the two phone lines are in one modular jack, connect using **TEL LINE 1-2** jack.
- If the two phone lines are on two separate modular jacks, connect using both **TEL LINE 1-2** and **TEL LINE 2** jacks.

- After installing the battery pack in the handset, **charge your handset at least 15-20 hours before plugging into the phone line.**

- 5) Once the handset battery pack is fully charged, connect the telephone line cord to the **TEL LINE 1-2** jack and a telephone outlet once the handset is fully charged.



If your telephone outlet isn't modular, contact your telephone company for assistance.



Modular

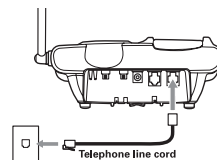

Mounting the Base Unit on a Wall

Setting the handset retainer clip for wall mounting

- 1) On the base unit, pull the handset retainer clip out of the slot and rotate it clockwise 180 degrees.
- 2) Flip the retainer clip from front to back. Slide it back into the slot so that the lip of the retainer is up and the ▼ is down. The retainer holds the handset in place.

Flip the hook tab over so the tab holds the handset.

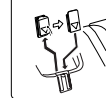

Standard wall plate mounting

This phone can be mounted on any standard wall plate.

- 1) Snap the wall mount adapter into the notches on the base bottom.
- 2) Plug the AC adapter to the **DC IN 9V** jack.
- 3) Route the AC adapter cord through the molded wiring channel as shown.
- 4) Plug the AC adapter into a standard 120V AC wall outlet.
- 5) Plug the telephone line cord into the **TEL LINE** jack. Route the cord through the molded wiring channel as shown.
- 6) Plug the telephone line cord into the telephone outlet.
- 7) Raise the antenna to a vertical position.
- 8) Align the mounting slots on the base with the mounting posts on the wall. Then push in and down until the phone is firmly seated.

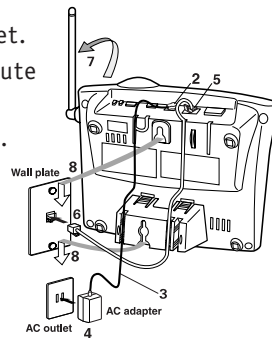
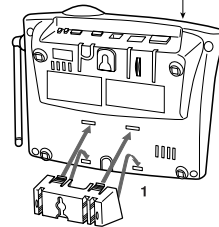

DO NOT use an outlet controlled by a wall switch.

Direct wall mounting

If you don't have a standard wall plate, you can mount your phone directly to the wall. Before doing this, consider the following:

- Avoid electrical cables, pipes, or other items behind the mounting location, that could cause a hazard when inserting screws into the wall.
- Try to mount your phone within 6-10 feet of a working phone jack to avoid excessive cord lengths.
- Make sure the wall material is capable of supporting the weight of the base and handset.
- Use #10 screws (minimum length of 1-3/8 inches) with anchoring devices suitable for the wall material where the base unit will be placed.

- 1) Insert two mounting screws into the wall, (with their appropriate anchoring device), 3-15/16 inches apart. Allow about 1/8 of an inch between the wall and screwheads for mounting the phone.
- 2) Set the retainer clip if necessary.
- 3) Refer to steps 1 through 8 on page 13 to mount the telephone.

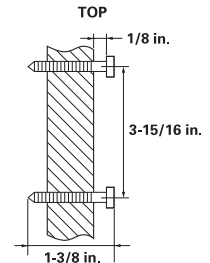

Setting Menu Options

There are four setup options available. They are Caller ID options [AutoTalk, CIDCW (Caller ID on Call Waiting), Area Code], and Language. See page 17 for Area Code setup instructions.

AutoTalk allows you to answer the phone without pressing the **line 1** key or the **line 2** key. If the phone rings when AutoTalk is on, simply remove the handset from the base and the phone automatically answers the call. Or if the handset is not on the base, press any key on the handset to answer the call. If the phone rings when AutoTalk is off, you must press the **line 1** key or the **line 2** key to answer the call.

Caller ID on Call Waiting (CIDCW) performs the same as regular Caller ID on a call waiting number. **You must subscribe to CIDCW from your phone company in order to use this feature.**

To change your AutoTalk and CIDCW:

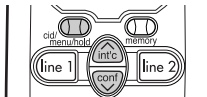
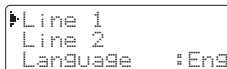
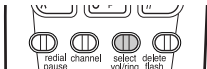
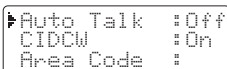
- When the phone is in the standby mode, press and hold the **cid/menu/hold** key until the Caller ID setting screen appears.
 

- Press the **^/int'c** key or the **∨/conf** key to select "Line 1" or "Line 2".
 

- Press the **#/>** key. The following screen appears.
- Press the **^/int'c** key or the **∨/conf** key to move the cursor to the selection that you would like to change. Press the **select/vol/ring** key to toggle between "On" and "Off".
- After you have made your selections, press the **cid/menu/hold** key or return the handset to the base.



The EXI3226 series features include **AutoTalk™** and **AutoStandby™**. AutoStandby allows you to hang up by simply returning the handset to the base.



- Make sure your battery pack is fully charged before setting Caller ID options.
- Please return the handset to the base after you set CIDCW.

D. Choosing the dialing mode

Most phone systems use tone dialing which sends DTMF tones through the phone lines. However some phone systems still use pulse dialing such as in rural areas. The default setting is tone dialing. Depending on your dialing system, set the mode as follows:

- 1) Press and hold the **flash** key on the base until you hear a confirmation tone.
 - 2) To set the dial mode for pulse dialing, press **#** on the base. Or to set the dial mode for tone dialing, press *** / tone** on the base. A confirmation tone sounds to indicate the setting is complete.
- If you are not sure of your dialing system, set for tone dialing. Make a trial call. If the call connects, leave the setting as is, otherwise set for pulse dialing.
 - If your phone dialing system requires pulse dialing and you need to send DTMF tones for certain situations during a call, you may "switch-over" to tone dialing. (Refer to "Tone Dialing Switch-over" on page 21).

To Enter Your Area Code

If you enter a 3-digit area code number in the “Area Code” option, your local area code does not appear in the Caller ID messages. Do not program this option, if your calling area requires 10-digit dialing. When reviewing Caller ID messages, you will see only the local seven digit number. For calls received from outside your local area code, you will see a full 10-digit number.

- 1) When the phone is in the standby mode, press and hold **cid/menu/hold** until the Caller ID setting screen appears.

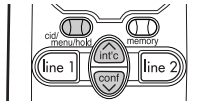

```
# Line 1
Line 2
Language : Eng
```

- 2) Press **^/intc** or **∨/conf** to select “Line 1” or “Line 2”.
- 3) Press **#/ >**.

- 4) Press **^/intc** or **∨/conf** to select “Area Code”.

```
▶ Auto Talk : Off
CIDCW      : On
Area Code  :
```

- 5) Press **select/vol/ring**.

- 6) Use the dial buttons (**0 - 9**) to enter the 3-digit area code.

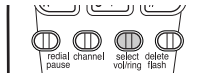

```
Auto Talk : Off
CIDCW     : On
Area Code : 81
```

- 7) Press **select/vol/ring**. A tone sounds and the displayed area code is entered.
- 8) Press **cid/menu/hold** to complete the setting. Or return the handset to the base unit. The handset returns to standby mode.

note When the area code has already been stored in memory, the stored area code will be displayed. To change it, use the **delete/flash** and number keypad to enter the new area code. Then press **select/vol/ring**. To complete the setting, press **cid/menu/hold** or return the handset to the base unit.

```
Auto Talk : Off
CIDCW     : On
Area Code : 81
```



If your calling area requires 10-digit dialing, do not program this option.

Setting the language

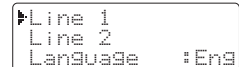

- 1) When the phone is in the standby mode, Press and hold **cid/menu/hold**. The following screen appears.
- 2) Press **∨/conf** twice to select "Language".
- 3) Press **select/vol/ring** to toggle between "Eng"(English) and "Fr."(French) for each setting.
- 4) Press **cid/menu/hold** or return the handset to the base unit. The handset returns to the standby mode.



```
▶Line 1
Line 2
Language : Eng
```

Making and Receiving Calls

Basic 2-line operation

	Handset On Base 	Handset Off Base 	Base Only 
To answer a call	Pick up the handset (AutoTalk) or pick up the handset and press line 1 or line 2 .	Press line 1 or line 2 , any number, */tone/ < or #/ > keys (Auto Talk: On).	Press line 1 or line 2 .
To make a call	<ol style="list-style-type: none"> 1) Pick up the handset. 2) Press line 1 or line 2. 3) Listen for the dial tone. 4) Dial the number. <p>OR</p> <ol style="list-style-type: none"> 1) Pick up the handset. 2) Dial the number, then press line 1 or line 2. 	<ol style="list-style-type: none"> 1) Press line 1 or line 2. 2) Listen for the dial tone. 3) Dial the number. <p>OR</p> <p>Dial the number, then press line 1 or line 2.</p>	<ol style="list-style-type: none"> 1) Press line 1 or line 2. 2) Listen for the dial tone. 3) Dial the number.
To hang up	Press line 1 or line 2 , or return the handset to the base (Auto Standby).		Press line 1 or line 2 .
To redial	<ol style="list-style-type: none"> 1) Pick up the handset. 2) Press line 1 or line 2. 3) Listen for the dial tone. 4) Press redial/pause. <p>OR</p> <ol style="list-style-type: none"> 1) Pick up the handset. 2) Press redial/pause, then press line 1 or line 2. 	<ol style="list-style-type: none"> 1) Press line 1 or line 2. 2) Listen for the dial tone. 3) Press redial/pause. <p>OR</p> <p>Press redial/pause, then press line 1 or line 2.</p>	<ol style="list-style-type: none"> 1) Press line 1 or line 2. 2) Listen for the dial tone. 3) Press redial/p.



- You must have a 2-line subscription from your phone company to use the 2-line features.
- Refer to page 15 to turn on the AutoTalk feature if desired.

Adjusting the Ringer and Earpiece/Speaker Volume

Ringer volume

When the phone is in standby mode, pressing the **select/vol/ring** on the handset selects the handset ringer volume. There are three (High, Low, Off) ringer volume levels. Press the **select/vol/ring** key to listen to volume levels. The phone keeps the last ringer volume setting selected.

Earpiece volume

The handset earpiece volume settings (Low, Medium, High and Maximum) can only be adjusted during a call. Press **select/vol/ring** repeatedly to select Low, Medium, High or Maximum. When you hang up, the phone keeps the last volume setting selected.

Base ringer volume

The ringer control for the base of your EXI3226 allows you turn the ringer OFF or to select LO/HI volume for each line 1 or line 2.

Base speaker volume

To control the speaker volume of the base, press **volume** \wedge or **volume** \vee during a call. There are 7 speaker volume levels.

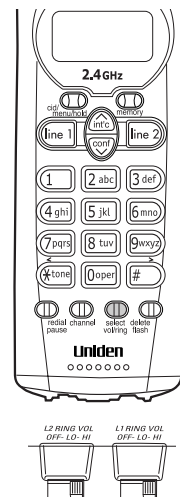

Redial

The **redial/pause** key redials the last number dialed. The redialed number can be up to 32 digits long.

Handset

Press **line 1** or **line 2**, then press **redial/pause**.
Or press **redial/pause**, then press **line 1** or **line 2**.

Base

Press **line 1** or **line 2**, then press **redial/p**.
If any key is pressed before **redial/p**, the last number will not redial.

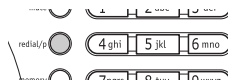
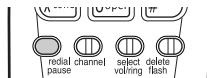

Tone Dialing Switch-over

Some telephone companies use equipment that requires pulse dialing (sometimes referred to as rotary dialing). If you need to enter tone dialing digits, you can switch-over to tone dialing during the call. For example, entering your bank account number after you have called your bank.



Initially make your call with the pulse dialing mode. Once your call connects, press ***tone/**<. Enter the desired number. These digits will be sent as tone dialing. Once the call ends, the tone mode is canceled and pulse dialing mode resumes.

Traveling Out-of-Range

During a call, as you begin to move your handset too far from your base unit, noise increases. If you pass the range limits of the base unit, your call will terminate within 60 seconds.

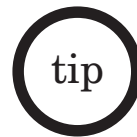

The EXI3226 has two independent last number redial memories; one in the handset, the other in the base.



- The tone feature only applies when the dial mode is set to pulse.
- This special number can be stored in a memory location. This is referred to as Chain Dialing.



The **UltraClear Plus™** true compander circuitry virtually eliminates background noise. This innovative technology, together with 20 different channels, provides you with the best possible reception during all your conversations.



The flash feature does not function when **line 1** and **line 2** are on a conference call. (See 3-way conferencing and 4-way conferencing, pages 27 and 28).

Selecting a Different Channel

If you encounter interference while using your phone, you can manually change the phone's channel for clear operation. This function works only when the phone is in use.

The **channel** on the handset allows you to choose between 20 different channels. During the course of a conversation, if you hear static or noise which makes it difficult to hear, press **channel**. The following screen appears and the phone changes to a different channel. For more information on interference, refer to page 52.

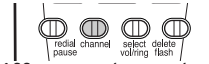

Using the Page Feature

To locate the handset (when it is off the base), press **intercom** on the base. The handset beeps for 60 seconds. The following screen appears: Press any key on the handset to connect to the base. Press **intercom** on the base to return to standby.

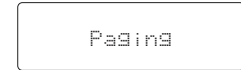
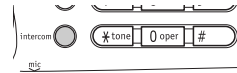

Flash and Call Waiting

If you have "Call Waiting" service and a call waiting tone sounds while you are on a call, press **delete/flash** to accept the waiting call. There is a short pause, then you will hear the new caller. To return to the original caller, press **delete/flash** again.

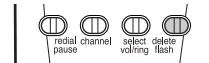

You must subscribe through your local telephone company to receive Call Waiting Service.

Using the Speakerphone

You may use the phone as a speakerphone to answer calls by pressing the **line 1** or **line 2** button on the base. To hang up, press **line 1** or **line 2** again.

The base microphone is located under the phone. Position yourself as near to the base as possible and speak clearly.

If the handset is on the base, you may use either the base keypad or memory dialing to place a call.

Answering a Call from the Base

1) The base rings. The corresponding **line 1** LED on the base flashes.

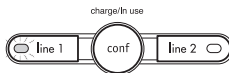

2) Press **line 1** and speak.

3) When you finish the call, press **line 1** to hang up.

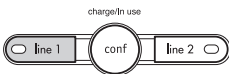

Answering a Call from the Handset

1) The handset rings and the following screen appears:

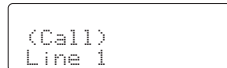

2) Press **line 1** to answer your call.

3) When you finish the call, press **line 1** on the handset, or return the handset to the base.

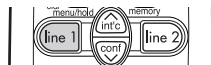

If you set the handset to AutoTalk On, and the handset is on the base, just pick up the handset and speak. Each line setting is independent for this feature.

Making a Call from the Base

- 1) Press **line 1**.
- 2) Dial the number on the keypad, or use one of the memory features. (See “Making Calls with Memory Dialing”, page 34.)
- 3) When you finish the call, press **line 1** to hang up.

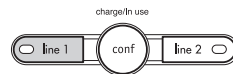

AutoStandby automatically hangs up when you place the handset on the base. There is no need to press **line 1** or **line 2** to hang up.



If a line is in use, or a phone is off the hook, “In Use Line 1 (or Line 2)” appears on the display.

Making a Call from the Handset

Dialing from Talk Mode

- 1) Pick up the handset.
- 2) Press **line 1**.
- 3) Dial the number on the keypad. Or use one of the memory features. (See “Making Calls with Memory Dialing”, page 34.)
You have to use number keys when you use memory key.
- 4) When you finish the call, press **line 1** or, return the handset to the base.



Dialing from Standby Mode

To call a number while the handset is in standby mode, dial the number on the keypad, or use one of the memory features. Press **line 1**. (See “Making Calls with Memory Dialing”, page 34.)

Placing a Call on Hold

Use either the keypad on the handset or the keypad on the base.

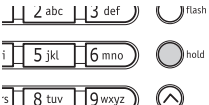
- 1) To place line 1 on hold at the base, press **hold**. The **line 1** red LED flashes.

- 2) To place line 1 on hold at the handset, press **cid/menu/hold**.
The following screen appears:



- 3) To pick up the call that is holding, press **line 1** on the base or handset.

Using the Speakerphone Mute Feature

Your EXI3226 allows you to mute your conversation from the base.

This prevents the party you are speaking to from hearing what you, or someone else in the room, is saying.

For example, to use this privacy feature while using line 1.

- 1) Press **mute**.
The **line 1** LED flashes green.
You can hear the party on line 1, but they cannot hear you.

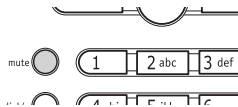

- 2) When you are ready to continue your conversation with the party on line 1, press **mute** or line 1 again. The **line 1** LED stops flashing.



- When you attempt to make a call, the EXI3226 informs you if a line is currently in use.
- If you want to join a conversation on an extension currently in use, press **line 1** or **line 2**.

2-Line Operation

The handset and the base can be used on separate telephone lines at the same time. For example, if the handset is on a call using line 1, you can make, or receive calls at the base on line 2.

The **line 1** LED on the base flashes green to indicate line 1 is In Use at the handset.

When line 1 is In Use at the base, the LCD screen displays the following:



Extension In Use

The Extension In Use feature prevents accidental interruption of ongoing telephone conversations.

If you attempt to make a call and another phone is In Use on line 1, the handset LCD indicates an extension is In Use. (The **line 1** LED at the base blinks.)

3-Way Conferencing

This feature lets you add a third party to your conversation from either the handset or the base.

For example, to add a party to the current call on line 1 at the base:

- 1) Press **hold** to place the caller on hold.
The **line 1** LED turns from green to flashing red.
 - 2) Press **line 2**.
 - 3) Dial the number of the person you want to add to the conversation.
When the person answers, you can speak privately before bringing the original caller back on the line.
 - 4) Press **conf** to bring the original call back on line. The **line 1** and **line 2** LEDs are green.

If the third person's number is busy or doesn't answer, press **line 2** to hang up. Return to the original call by pressing **line 1**.
 - 5) To remove either caller from your conversation, ask one of the parties to hang up. Press the corresponding line button to end the call.
- Follow steps 1-5 to conference using the handset. When you return the handset to the base, all calls are disconnected.

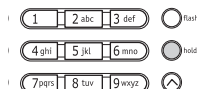
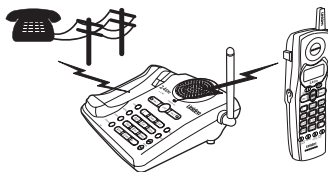

The flash feature does not function when the phone is in conference mode.

4-Way Conferencing

A fourth person, at either the handset or the base, can be added to a conference call.

For example, to add a fourth party at the handset to an ongoing conference call at the base:

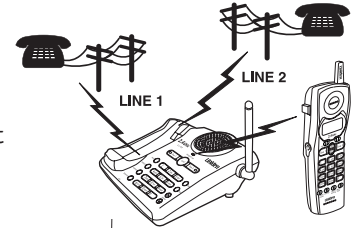

- 1) Press **hold**. The **line 1** and **line 2** LEDs flash red.

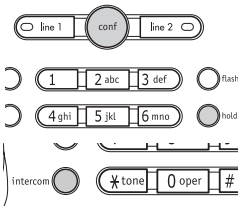

- 2) Press **intercom** on the base to contact the handset.

- 3) Press **int'c** on the handset. Speak to answer the page.

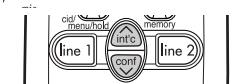

- 4) Press **conf** at the base or **∨/conf** at the handset to bring the party at the handset in on the call. The **line 1** and **line 2** LEDs are green.

The following screen appears:

- 5) To remove either caller from your conversation, ask one of the parties to hang up. Press the corresponding line button to end the call.

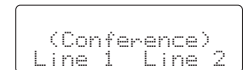

Using Your EXI3226 intercom

Paging from the base to handset

- 1) Press **intercom** on the base.
The handset beeps. (If no answer, press **intercom** on the base again to disconnect.)
- 2) Press any key on the handset.
Speak into the mouthpiece to answer the page.
- 3) To turn off the intercom, press **intercom** on the base or \wedge /**int'c** on the handset.

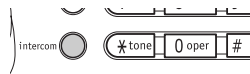

Paging from the handset to base

- 1) Press \wedge /**int'c** on the handset. (If no answer, press \wedge /**int'c** on the handset to disconnect.)
- 2) At the base, press **intercom**.
Speak into the base microphone to answer the page.
- 3) To turn off the intercom, press **intercom** at the base or \wedge /**int'c** on the handset.

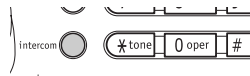
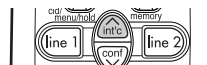

Transferring Calls

- 1) To transfer a call from the base or handset, press **hold**. The **line 1** LED flashes red.
- 2) Press **intercom**/**^/int'c**.
- 3) Answer the transferred call by pressing **^/int'c/intercom**. On the base the **charge/in use** LED illuminates.
The following screen appears.
You may then announce the call with the intercom.
- 4) To speak to the caller, press **line 1**.

If no one is available to take the call, you can return to the caller by pressing **line 1** to take a message or complete the call.

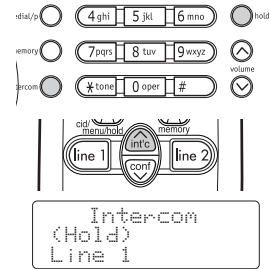

Storing Phone Numbers and Names

Memory Dialing allows you to dial a number using just a few key presses. Your EXI3226 stores up to 30 names/numbers in the handset plus 10 numbers in the base. Memory locations are shared by both lines.

With the handset

1) Pick up the handset from the base.

2) Press **memory**.

The following screen appears:



3) Use the **^/int'c** and **∨/conf**, or number keypad (**01-30**), to choose the memory location to store a name/number.

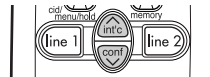

4) Press **select/vol/ring**.

5) Press **select/vol/ring**.

The following screen appears:



6) Entering a stored name - "Use the number keys, ***/tone/ <, #/>**, or **delete/flash** to edit the name. (See page 33).
To edit only the phone number, skip this step."

7) When you have finished entering a name, press **select/vol/ring**. The following screen appears. The cursor flashes, indicating that the display is ready for a number to be entered.

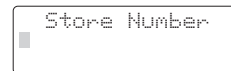

Whenever you are using a menu screen, you must press a key within 30 seconds or the phone will return to standby. You may also press **memory** to exit a memory menu at anytime.



Each pause counts as one digit and represents a two second delay of time between the digits as they are sent. The pause feature is useful for long distance calling, credit card dialing, or any other dialing sequence requiring a pause between digits.

- 8) Enter the phone number with the number keypad. If you want to change the entered number, press **delete/flash** and the cursor will move one space to the left and delete that number.

When entering numbers, you may press **redial/pause** to enter a pause in the dialing sequence. The display shows a "P".
The phone number cannot exceed 20 digits.

- 9) When you have finished entering a name/number, press **select/vol/ring**. You will hear a confirmation tone, and the following screen appears.

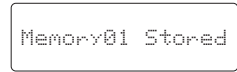
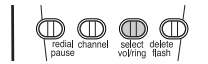

With the base

- 1) Press **memory**. The **charge/in use** LED blinks.
- 2) Dial the number you wish to store. The phone number cannot exceed 20 digits.
- 3) Press **memory**. Enter the memory location number (**0 - 9**) on the keypad. The **charge/in use** LED is no longer illuminated. A confirmation tone indicates the number is stored.

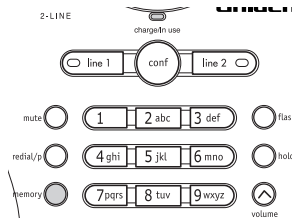

Steps for Entering Names and Special Characters

Refer to the letters on the number keys to select the desired characters. With each press of a numeric key, the displayed character appears in the following order: Upper case letters first, lower case letters next and finally the number corresponding to the key.

If you make a mistake while entering a name

Use the ***/tone/**< or ***/>** key to move the cursor to the incorrect character. Press **delete/flash** to erase the wrong character, then enter the correct character. To delete all characters, press and hold **delete/flash**.

For example, to enter Movies.

- 1) Pick up the handset. Press **memory**.
- 2) Enter a number or press the **^/int'c** or **∨/conf** key to select a memory location.
- 3) Press **select/vol/ring**.
- 4) Press **select/vol/ring**. (When there is information already stored in the selected memory location, "Edit MemoryXX" is displayed. See page 35 for information on "Editing a Stored Name and/or Phone Number".)
- 5) Press **6** then press ***/>** to move the cursor to the right.
- 6) Press **6** six times.
- 7) Press **8** six times.
- 8) Press **4** six times.
- 9) Press **3** five times.
- 10) Press **7** eight times.
- 11) When finished, press **select/vol/ring**.

keys	Number of times key is pressed								
	1	2	3	4	5	6	7	8	9
1	1								
2abc	A	B	C	a	b	c	2		
3def	D	E	F	d	e	f	3		
4ghi	G	H	I	g	h	i	4		
5jkl	J	K	L	j	k	l	5		
6mno	M	N	O	m	n	o	6		
7pqrs	P	Q	R	p	q	r	s	7	
8tuvw	T	U	V	t	u	v	8		
9wxyz	W	X	Y	w	x	y	z	9	
0	*	#	-	&	<	>	(blank)	0	

To continue to store the telephone number, proceed to step 8 on page 32.



If the next character uses the same number key, you must press ***/>** to move the cursor over. Otherwise the next time you press the number key, it changes the character that was previously set.



- To exit the memory function without dialing press **memory**. The handset returns to standby.

- When reviewing memory location you must press a key within 30 seconds or the phone will return to standby.

Making Calls with Memory Dialing

Follow the steps below to dial a number using a programmed memory location:

With the handset

- 1) Press **memory**. The handset displays your programmed memory locations.

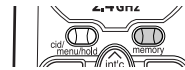

- 2) Press **^/int'c** and **∨/conf**, or enter the number **(01-30)** to select the memory location you would like to dial. The following screen appears:

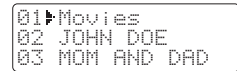
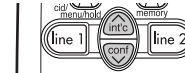

- 3) Press **line 1** or **line 2**. The number dials.

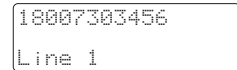
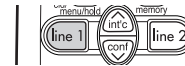

With the base

- 1) Press **line 1** or **line 2**. The line's LED illuminates.
- 2) Press **memory**. Enter the memory location number **(0-9)**, to dial the number.

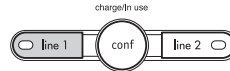

Chain Dialing

The 30 memory locations on the handset are not limited to phone numbers. You may want to store in memory a group of numbers (up to 20 digits) that you need to enter once your call connects. This is referred to as Chain Dialing.

An example of this is a bank account number. Once you have called your bank, when you are prompted to enter the account number, simply press **memory** and then select the location where the special number has been stored.

Store your special number in memory as you would a phone number. (Refer to “Storing Phone Numbers and Names”, on page 31)

Enter a “pause” in the sequence as necessary. A “pause” counts as one digit and represents a two second delay in time between digits as they are sent.

Editing a Stored Name and/or Phone Number

To edit a number you have stored in the handset.

- 1) Pick up the handset from the base.
- 2) Press **memory**. The display shows the “Select Memory” screen and any saved names/numbers.

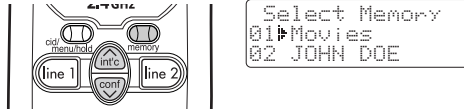

- 3) Use the \wedge /**intc** and \vee /**conf**, or number keypad, to select the memory location (**01-30**) you would like to edit.
- 4) Press **select/vol/ring**.



- When reviewing memory location you must press a key within 30 seconds or the phone will return to standby.
- If you select “Go Back”, no changes are made and the handset shows the “Select Memory” screen.

5) Press **select/vol/ring**. The display shows the memory location you have selected.

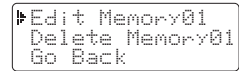
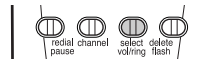

6) Press **select/vol/ring** again to enter the “Edit Memory” mode.

7) The following screen appears, and a cursor flashes indicating that the display is ready to edit the name.



8) Entering a stored name - “Use the number keys, ***/tone/ <** , ***/# / >**, or **delete/flash** to edit the name. (See page 33) To edit only the phone number, skip this step.”

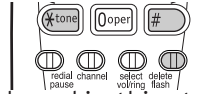

9) Press **select/vol/ring**. The following screen appears. A cursor flashes indicating that the display is ready for the number to be edited.

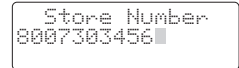

10) Enter the phone number with the number keypad (direct entry). Press **delete/flash** to remove any unwanted character. Press and hold **delete/flash** to clear the entire number.

11) Press **select/vol/ring**. If you changed either name or phone number, a confirmation display shows up. If it is correct, press **^/int'c** and press the **select/vol/ring** key again. You will hear a confirmation tone, and the following screen appears.

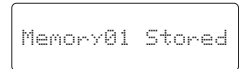
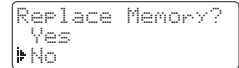

12) The display then returns to the “Select Memory” screen. You may select another number to edit (return to step 3) or press **memory** to return to standby. To edit a number stored in the base, repeat the steps for storing numbers in the base. (See page 32.) This will simply overwrite the number that was previously stored in the location.

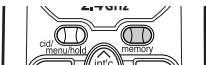

Erasing a Stored Name and Phone Number

With the handset

1) Pick up the handset from the base.

2) Press **memory**. The handset shows the "Select Memory" screen with saved name/numbers displayed.

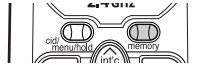

```
Select Memory
01 Movies
02 JOHN DOE
```

3) Use the **^/int'c** and **∨/conf**, or number keypad (**01-30**), to select the memory location you would like to delete.

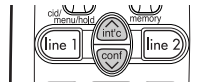

4) Press **select/vol/ring**.

5) Press **select/vol/ring**.
The following screen appears:

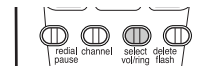

```
Edit Memory01
Delete Memory01
Go Back
```

6) Use the **∨/conf** to move the cursor to "Delete Memory01".

```
Edit Memory01
Delete Memory01
Go Back
```

7) Press **select/vol/ring**.

8) Use the **^/int'c** to move the cursor to "Yes".

```
Delete Memory01?
Yes
No
```

9) Press **select/vol/ring** or **delete/flash**.
There is a confirmation tone,
and the following screen appears:

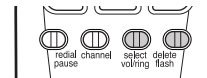

```
Memory01 Deleted
```



- If you select "Go Back", no changes are made and the handset shows the "Select Memory" screen.
- If you select "No", no changes are made, the handset shows the "Select Memory" screen.

- 10) The display then returns to the “Select Memory” screen. You may select another number to delete (return to step 3) or you may press **memory** to return to standby.

With the base

- 1) Press **memory**.

- 2) Press **memory** again. Enter the memory location (**0-9**) of the number you wish to delete.

A confirmation tone indicates the number has been deleted.

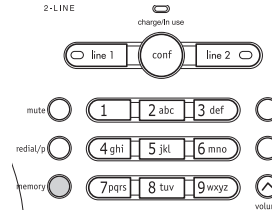

Caller ID

You must subscribe to Caller ID from your phone company to use this feature.

When the telephone rings, the Caller ID feature allows you to review caller's name and phone number on the display before you answer the phone. At the second ring, the handset displays the phone number of the incoming call, the name. If your Caller ID service is number only, the name does not appear on the second line.

If a name or number is not available, the display shows a message such as "Incomplete Data", "Private Number", "Private Name", "Unknown Name", etc.

Additionally, you can dial the displayed number and store the information for memory dialing. Make sure you have turned on the Caller ID/Call Waiting feature (See page 15).

When the Telephone Rings

- 1) When the Caller ID message is received, the display shows the caller's phone number along with the name. The incoming call information is stored in the Caller ID record. If the Caller ID service includes the caller's name, the caller's name appears on the display (up to 15 letters).

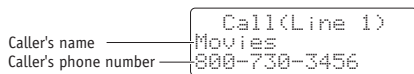

- If you answer a call before the Caller ID message is received (Example : before the second ring), the Caller ID message will not appear.
- When the call is received via a telephone company that does not offer Caller ID service, the caller's phone number and name does not appear. (This includes international calls.)
- When the call is via a private branch exchange (PBX), the caller's phone number and name may not appear.



- If you have no Caller ID name/numbers, then the total is shown as “00”.
- Once a Caller ID message has been viewed, it is no longer considered a new message.

Viewing the Caller ID Message List

The Caller ID list stores information for up to 80 incoming calls - even unanswered calls.

To review your Caller ID names/numbers, follow the steps below:

- 1) Press **cid/menu/hold**.

The following screen appears:

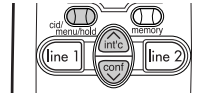

	Line 1	Line 2
▶	NEW 00	01
	TTL 02	01

- 2) Use ***/tone/ < or #/ >** to select “Line 1” or “Line 2” for Caller ID.
- 3) Press **∨/conf** to see the next message.
Or press **^/int'c** to see previous message.
- 4) Press **cid/menu/hold** to return to standby.

Using the Caller ID List

Calling a Caller ID name/number

You can place a call from the Caller ID list. The EXI3226 stores up to 80 messages.

1) Press **cid/menu/hold**. The Caller ID summary screen shows the number of new callers and total number of calls.

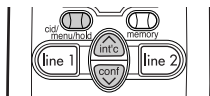

▶	Line 1	Line 2
NEW	01	02
TTL	02	04

2) Use ***/tone/<** or **#/>** to select "Line 1" or "Line 2" Caller ID.

3) Press **∨/conf** to scan forward.

Press **∧/int'c** to scan backwards through the list.

4) Select the name/number that you would like to dial.

12/21	12:30PM	03
Jane Smith		
214-555-1234		

5) Press **line 1** or **line 2**. The number automatically dials.

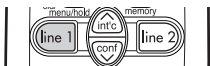

Long Distance calls and Area Cord Setting/Cancellation

Pressing **1** while the incoming Caller ID information is displayed (in step 3) will place the prefix "1" in the display to setup for a long distance call.

Pressing **3** will set or cancel an area code setting.

note

- In Caller ID operation, if no key is pressed for more than 30 seconds, an error tone sounds and the telephone returns to the standby mode.
- If a call comes in via a telephone system that does not offer Caller ID service, no information is stored.
- Each message can be up to 15 characters for the phone number and the name.
- The number of calls from the same Caller ID appears next to the received time. Once you view the new calls, the number will disappear.

Storing a Caller ID number in a memory location

- 1) Press **cid/menu/hold**. The Caller ID summary screen shows the number of new callers and total number of calls.

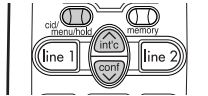

	Line 1	Line 2
NEW	00	01
TTL	02	01

- 2) Use ***/tone/ <** or ***/ >** to select "Line 1" or "Line 2" Caller ID.
- 3) Press **^/int'c** or **∨/conf** to find the name/number that you would like to store.
- 4) Press **memory** to store the selected message.
The following screen appears:

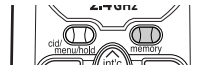

Select Memory	
01	Jane Smith
02	Movies

- 5) The "Select Memory" screen appears. Use the **^/int'c** and **∨/conf**, or enter the number (**01-30**) to select a blank memory location where you would like to store the number.
(If you want to replace an existing number with the Caller ID number, skip to step 7).
- 6) Press **select/vol/ring**. A confirmation tone sounds. The number is programmed.
- 7) If you choose to replace an existing number with the Caller ID number, press **select/vol/ring**.
The following screen appears:
- 8) Use the **^/int'c** to move the cursor to "Yes". Press **select/vol/ring**.
A confirmation tone sounds and the number is programmed.

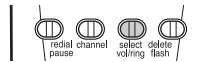

Replace Memory?	
Yes	
▶ No	



If you select "No", then the Caller ID screen returns.

Deleting Information from the Caller ID List

The EXI3226 stores up to 80 messages. If the phone receives the 81st message for each line, the oldest one in the list is automatically deleted. Caller ID data can also be deleted manually.

Deleting a Caller ID message

To delete a single Caller ID message, follow the steps below.

1) Press **cid/menu/hold**. The Caller ID summary screen shows the number of new callers and total number of calls.

2) Use ***/tone/** < or ***/#** > to select "Line 1" or "Line 2" Caller ID.

3) Press **^/int'c** or **∨/conf** to find the name/number.

4) Press **delete/flash**.

The following screen appears:

5) Press **select/vol/ring** or **delete/flash**. A confirmation tone sounds. The Caller ID screen returns with the next name/number displayed.

If you select "No", the Caller ID screen returns.

6) Press **cid/menu/hold** to return to standby.

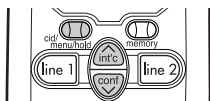

Line 1	Line 2
NEW 00	01
TTL 02	01

12/21 12:30PM 03
Jane Smith
214-555-1234

Delete Message?
▶ Yes
No



- While using the "Delete All?" or "Delete Message?" screen if no key is pressed within 30 seconds, an error tone sounds and the telephone returns to standby.
- If you get an incoming call or page, the deleting operation is canceled so you can answer the call or page.

Deleting all Caller ID name/numbers

To delete all of your Caller ID messages, follow the steps below.

- 1) Press **cid/menu/hold**. the Caller ID summary screen shows the number of new callers and total number of calls.

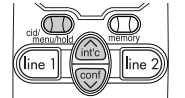

	Line 1	Line 2
NEW	00	01
TTL	02	01

- 2) Use ***/tone/ < or #/ >** to select "Line 1".
- 3) Press **delete/flash** to delete name/numbers on line 1. The following screen appears:
- 4) Use the **^/int'c** to move the cursor to "Yes".
- 5) Press **delete/flash** or **select/vol/ring**. A confirmation tone sounds. The following screen appears:
- 6) Repeat steps 3 through 5 for line 2. All your Caller ID messages are deleted.

Del All, Line 1?
Yes
▶No

	Line 1	▶Line 2
NEW	00	02
TTL	00	04

Using CIDCW (Caller ID on Call Waiting)

- 1) During a call, when you hear the Caller ID tone, check the handset display for the name and the number of the incoming call.
- 2) Press **delete/flash** to accept the incoming call. See Flash and Call Waiting, page 22.

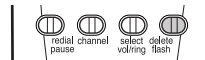

Call(Line 1)
Jane Smith
214-555-1234

Changing the Digital Security Code

The digital security code is an identification code used to connect the handset and the base unit. Normally, setting the code is not necessary.

The first time you charge your handset, the security code is automatically set. In the rare situation that you suspect another cordless telephone is using the same security code, you can change the code.

- 1) Remove the handset from the base unit.
- 2) Press and hold **intercom** on the base.
- 3) While holding **intercom**, place the handset on the base unit. The paging sound stops. Leave the handset on the base for more than 5 seconds. A new random security code is set.

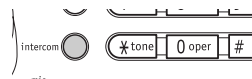

If the handset battery pack is completely discharged or the battery pack is removed, the digital security code will be lost.

If this happens, a new security code is set automatically next time the battery pack is charged.

- To protect you against misbilled calls which might result from your phone being activated by other equipment, the cordless phone has **AutoSecure™** feature electronically locks your phone when the handset is on the base. Also, the **Random Code™** digital security which automatically selects one of over 65,000 digital security codes for the handset and base.

Installing the Beltclip

To attach the beltclip

Insert the beltclip into the holes on each side of the handset. Press down until it clicks.

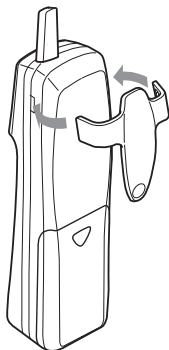

To remove the beltclip

Pull both sides of the beltclip to release the tabs from the holes.

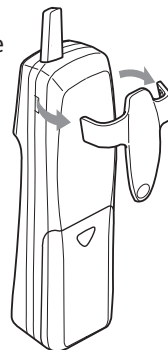

Headset Installation

Your phone may be used with an optional headset, the Uniden HS910. To use this feature, insert the headset plug into the headset jack. Your phone is ready for hands-free conversations. (Headset may be purchased by calling the Uniden Parts Department or visiting the web site. See QUICK REFERENCE GUIDE on page 3.)

If you are using an optional headset, you must still use the handset keypad for phone operations.

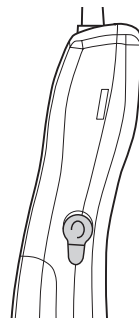

Use only Uniden HS910 headset specifically designed for Uniden phones.

Note on Power Sources

Battery replacement and handling

When the operating time becomes short, even after a battery is recharged, please replace the battery. With normal usage, your battery should last about one year.

Please contact your place of purchase or the Uniden Parts Department for a replacement battery.

Warning: To avoid the risk of personal injury or property damage from fire or electrical shock, only use the Uniden battery model and Uniden adapter model specifically designated for this product.

Power Failure

During the period that the power is off, you will not be able to make or receive calls with the telephone.

Caution

- Use only the specified Uniden battery pack. (BT-905)
- Do not remove the battery from the handset to charge it.
- Never throw the battery into a fire, disassemble it, or heat it.
- Do not remove or damage the battery casing.

Caution

Do not use paint thinner, benzene, alcohol, or other chemical products. Doing so may discolor the surface of the telephone and damage the finish.

Maintenance

When the handset or base unit becomes slightly dirty

Wipe with a soft, dry cloth.

When the handset or base unit becomes very dirty

Wipe with a soft cloth that has been dampened with diluted, neutral detergent. Dry with a dry cloth.

When the charging contacts become very dirty on both the handset and base unit

Using water only, dampen a cloth to clean the charging contacts. Then make sure to go back over the charging contacts with a dry cloth before returning the handset to the base unit to charge.

Troubleshooting

If your phone is not performing to your expectations, please try these simple steps first.

Symptom	Suggestion
The charge/in use LED won't light when the handset is placed on the base unit.	<ul style="list-style-type: none">• Make sure the AC adapter is plugged into the base unit and wall outlet.• Make sure the handset is properly seated on the base unit.• Make sure the charging contacts on the handset and base unit are clean.
The audio sounds weak and/or scratchy.	<ul style="list-style-type: none">• Press channel during a call to help eliminate background noise.• Make sure that the base unit antenna is in a vertical position.• Move the handset and/or base unit to a different location away from metal objects or appliances and try again.• Make sure that you are not too far from the base.
Can't make or receive calls.	<ul style="list-style-type: none">• Check both ends of the base unit telephone line cord.• Make sure the AC adapter is plugged into the base unit and wall outlet.• Disconnect the AC adapter for a few minutes, then reconnect it.• Change the digital security code (See page 45).• Make sure line 1 or line 2 is pressed.
The handset doesn't ring or receive a page.	<ul style="list-style-type: none">• The battery pack may be weak. Charge the handset on the base unit for more than 15 hours.• The handset may be too far away from the base unit.• Place the base unit away from appliances or metal objects.• Change the digital security code (See page 45).
Severe noise interference.	<ul style="list-style-type: none">• Keep the handset away from microwave ovens, computers, remote control toys, wireless microphones, alarm systems, intercoms, room monitors, fluorescent lights, and electrical appliances.• Move to another location or turn off the source of interference.
The Caller ID/CIDCW does not display.	<ul style="list-style-type: none">• The handset was picked up before the second ring.• The call was placed through a switchboard.• Call your local telephone company to verify your Caller ID service is current.• Make sure that the CIDCW option is set to "On".

Liquid Damage

Moisture and liquid can damage your cordless phone. In case of accidental submersion, please read the following steps.

Case	Action
If the handset or base is exposed to moisture or liquid, but only affects the exterior plastic housing.	Wipe off the liquid and use as normal.
If moisture or liquid has entered the plastic-housing (i.e. liquid can be heard in the phone or liquid has entered the handset battery compartment or vent openings on the base).	<p>Handset:</p> <ol style="list-style-type: none">1. Remove the battery cover and leave it off for ventilation.2. Remove the battery pack by disconnecting.3. Leave the battery cover off and the battery pack disconnected for at least 3 days.4. Once completely dry, reconnect the battery pack and the battery cover.5. Recharge the handset's battery pack for 20 hours on the base unit before using the phone. <p>Base:</p> <ol style="list-style-type: none">1. Disconnect the AC adapter from the base unit, cutting off electrical power.2. Disconnect the telephone cord from the base unit.3. Let dry for at least 3 days. <p>IMPORTANT: You must unplug the telephone line while recharging the battery pack to avoid charge interruption.</p> <p>CAUTION: DO NOT use a microwave oven to speed up the drying process. This will cause permanent damage to the handset, base and the microwave oven.</p> <p>After following these steps, if your cordless telephone does not work, please send to: Uniden America Corporation Parts and Service Division 4700 Amon Carter Blvd. Ft. Worth, TX 76155 1-800-554-3988. Monday through Friday 8 a.m. to 5 p.m. CST</p>

General Information

The phone complies with FCC Parts 15 and 68.

Operating temperature: -10°C to $+50^{\circ}\text{C}$ ($+14^{\circ}\text{F}$ to $+122^{\circ}\text{F}$)

AC Adapter Information

AC Adapter part number: AD-314

Input Voltage: 120V AC 60Hz

Output Voltage: 9V DC 350 mA

Battery Information

Battery part number: BT-905

Capacity: 600 mAh, 3.6V

Battery use time (per charge)

From fully charged

Talk mode duration: Up to 7 hours

Standby mode duration: Up to 14 days



- **To avoid damage to the phone use only Uniden AD-314 and BT-905 with your phone.**
- If the handset is left off of the base, the actual Talk mode duration will be reduced respective to the amount of time the handset is off the base.

Recharge your phone on a regular basis by returning the handset to the base after each phone call. When the operating time becomes short, even after the battery is recharged, please replace the battery. With normal usage, the battery should last about one year.

A replacement Uniden adapter and battery may be purchased at your local Uniden dealer or by contacting the Uniden Parts Department (800) 544-3988. Hours are from 8:00 a.m. to 5:00 p.m. Central Time, Monday through Friday. We can also be reached on the web at www.uniden.com.

Specifications, features, and availability of optional accessories are all subject to change without prior notice.

Precautions!

Before you read anything else, please observe the following:

Warning!

Uniden America Corporation DOES NOT represent this unit to be waterproof. To reduce the risk of fire, electrical shock, or damage to the unit, DO NOT expose this unit to rain or moisture.

Rechargeable Nickel-Cadmium Battery Warning

- This equipment contains a rechargeable nickel-cadmium battery.
- Cadmium is a chemical known to the State of California to cause cancer.
- The rechargeable nickel-cadmium battery contained in this equipment may explode if disposed of in a fire.
- Do not short-circuit the battery.
- Do not charge the rechargeable nickel-cadmium battery used in this equipment in any charger other than the one designed to charge this battery as specified in the owner's manual. Using another charger may damage the battery or cause the battery to explode.

Rechargeable Nickel-Cadmium Batteries Must Be Recycled or Disposed of Properly

- Uniden voluntarily participates in an RBRC® industry program to collect and recycle nickel-cadmium batteries at the end of their useful life, when taken out of service within the United States. The RBRC® program provides a convenient alternative to placing used nickel-cadmium batteries into the trash or municipal waste stream, which is illegal in some areas.
- Through the RBRC® program, Uniden makes it easy for you to drop off the used battery at local retailers of replacement nickel-cadmium batteries. You may also contact your local recycling center for information on where to return the used battery. Please call 1-800-8-BATTERY for information on Ni-Cd battery recycling in your area. Uniden's involvement in this program is part of its commitment to protecting our environment and conserving natural resources.
- RBRC® is a registered trademark of the Rechargeable Battery Recycling Corporation.

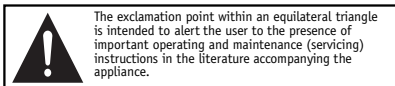

The exclamation point within an equilateral triangle is intended to alert the user to the presence of important operating and maintenance (servicing) instructions in the literature accompanying the appliance.

Uniden works to reduce lead content in our PVC coated cords in our product and accessories.

WARNING!

The cords on this products and/or accessories contain lead, a chemical known to the State of California to cause birth defects or other reproductive harm. **Wash hands after handling.**

Important Safety Instructions

When using your telephone equipment, these basic safety precautions should always be followed to reduce the risk of fire, electrical shock, and injury to persons:

1. Read and understand all instructions.
2. Follow all warnings and instructions marked on the product.
3. Unplug this product from the wall outlet before cleaning. Use a dry cloth for cleaning without liquid or aerosol cleaners.
4. Do not use this product near water; for example, near a bathtub, wash bowl, kitchen sink or laundry tub, in a wet basement, or near a swimming pool.
5. Do not place this product on an unstable cart, stand, or table. The telephone may fall, causing serious damage to the unit.
6. Slots and openings in the cabinet and the back or bottom are provided for ventilation. To protect the product from overheating, these openings must not be blocked or covered. This product should never be placed near or over a radiator or heat register. This product should not be placed in a built-in installation unless proper ventilation is provided.
7. This product should be operated only from the type of power source indicated on the marking label. If you are not sure of the type of power supply to your home, consult your dealer or local power company.
8. Do not allow anything to rest on the power cord. Do not locate this product where the cord will be damaged by persons walking on it.
9. Do not overload wall outlets and extension cords, as this can result in the risk of fire or electrical shock.
10. Never push objects of any kind into this product through cabinet slots, as they may touch dangerous voltage points or short out parts that could result in a risk of fire or electric shock. Never spill liquid of any kind on the product.
11. To reduce the risk of electric shock, do not disassemble this product. Take it to qualified service personnel when service or repair work is required. Opening or removing covers may expose you to dangerous voltages or other risks. Incorrect reassembly can cause electric shock when the appliance is subsequently used.
12. Unplug this product from the wall outlet and refer servicing to qualified service personnel under the following conditions:
 - A. When the power supply cord is damaged or frayed.
 - B. If liquid has been spilled into the product.
 - C. If the product has been exposed to rain or water.
 - D. If the product does not operate normally when following the operating instructions. (Adjust only those controls that are covered by the operating instructions. Improper adjustment of other controls may result in damage and will often require extensive repair work by a qualified technician.)
 - E. If the product has been dropped or the cabinet has been damaged.
 - F. If the product exhibits a distinct change in performance.
13. Do not use the telephone to report a gas leak in the vicinity of the leak.

Additional Battery Safety Precautions

Caution! To reduce the risk of fire or injury to persons by the battery, read and follow these instructions:

1. Use only the appropriate type and size battery pack specified in the owner's manual.
2. Do not dispose of the battery pack in a fire. The cell may explode. Check the nickel-cadmium battery disposal package insert for disposal instructions.
3. Do not open or mutilate the battery pack. Released electrolyte is corrosive and may cause damage to the eyes or skin. It may be toxic if swallowed.
4. Exercise care in handling the battery in order not to short the battery with conducting materials such as rings, bracelets, and keys. The battery or conductor may overheat and cause burns.
5. Charge the battery pack provided with or identified for use with this product only in accordance with the instructions and limitations specified in the owner's manual provided for this product.
6. Observe proper polarity orientation between the battery pack and battery charger.

SAVE THESE INSTRUCTIONS!

Important Electrical Considerations

Unplug all electrical appliances when you know an electrical storm is approaching. Lightning can pass through your household wiring and damage any device connected to it. This phone is no exception.

The FCC Wants You To Know

Changes or modifications to this product not expressly approved by Uniden, or operation of this product in any way other than as detailed by the owner's manual, could void your authority to operate this product. The equipment cannot be used on public coin phone service provided by the telephone company. Connection to party line service is subject to state tariffs. (Contact the state public utility commission, public service commission or corporation communication for information.)

NOTE:

- You must not connect your phone to:
 - coin-operated systems
 - most electronic key telephone systems

Range

Your new phone is designed to achieve the maximum possible range by transmitting and receiving according to the highest specifications set forth by the FCC. We have rated this phone to operate at a maximum distance with the qualification that the range depends upon the environment in which the telephone is used. Many factors limit range, and it would be impossible to include all the variables in our rating. The Maximum Range rating of this phone is meant to be used as a means of comparison against other range claims.

Telephone Line Problems

The FCC has granted the telephone company the right to disconnect service in the event that your phone causes problems on the telephone line. Also, the telephone company may make changes in facilities and services which may affect the operation of your unit. However, your telephone company must give adequate notice in writing prior to such actions to allow you time for making necessary arrangements to continue uninterrupted service. If you are having trouble with your telephone service, you must first disconnect your phone to determine if it is the cause of your problem. If you determine that it is the cause, you must leave it disconnected until the trouble has been corrected.

Radio Interference

Radio interference may occasionally cause buzzing and humming in your cordless handset, or clicking noises in the base. This interference is caused by external sources such as TV, refrigerator, vacuum cleaner, fluorescent lighting, or electrical storm. Your unit is NOT DEFECTIVE. If these noises continue and are too distracting, please check around your home to see what appliances may be causing the problem. In addition, we recommend that the base not be plugged into a circuit that also powers a major appliance because of the potential for interference. Be certain that the antenna on the unit is fully extended when needed. In the unlikely event that you consistently hear other voices or distracting transmissions on your phone, you may be receiving radio signals from another cordless telephone or other source of interference. If you cannot eliminate this type of interference, you need to change to a different channel. Finally, it should be noted that some cordless telephones operate at frequencies that may cause interference to nearby TVs and VCRs. To minimize or prevent such interference, the base of the cordless telephone should not be placed near or on top of a TV or VCR. If interference is experienced, moving the cordless telephone farther away from the TV or VCR will often reduce or eliminate the interference.

More than One Cordless Telephone

If you want to use more than one cordless telephone in your home, they must operate on different channels. Press the channel key to select a channel that provides the clearest communication.

Cordless Telephone Privacy

Cordless telephones are radio devices. Communications between the handset and base of your cordless telephone are accomplished by means of radio waves which are broadcast over the open airways. Because of the inherent physical properties of radio waves, your communications can be received by radio receiving devices other than your own cordless telephone unit. Consequently, any communications using your cordless telephone may not be private.

Installation Considerations

Selecting a Location

Before choosing a location for your new phone, there are some important guidelines you should consider:

- The location should be close to both a phone jack and continuous power outlet. (A continuous power outlet is an AC outlet which does not have a switch to interrupt its power.)
- Keep the base and handset away from sources of electrical noise such as motors or fluorescent lighting.
- Be sure there is sufficient space to fully extend the base antenna.
- The base can be placed on a desk or tabletop or mounted on a standard telephone wall plate.
- You should charge your new phone for 15-20 hours before completing the installation or using the handset.

Telephone Line Outlets

There are two types of phone outlets:

Modular Jack

Most phone equipment available now uses modular jacks. Phone cords are fitted with a molded plastic connector which plugs into this type of jack. If you do not have modular phone jacks, contact your local telephone company for information about their installation.

Hardwired Jack

Some equipment is wired directly to a phone jack, and these types of installations require a modular jack converter. This type of installation is not difficult; however, you should contact your Uniden telephone dealer or a telephone supply store for advice about the proper adapter or converter for your particular situation.

Connecting the Telephone Cords

Consider these safety guidelines before connecting the telephone cords:

Caution!

- *Never install telephone wiring during a lightning storm.*
- *Never touch uninsulated telephone wires or terminals unless the telephone line has been disconnected.*
- *Use caution when installing or modifying telephone lines.*

Applying Power to the Base

This phone requires an AC outlet, without a switch to interrupt power, and the included AC adapter. To relieve strain on the DC plug when the phone is placed on a desk or table, wrap the power cord around the strain relief notch on the bottom of the base.

NOTE: Place the power cord so that it does not create a trip hazard, or where it could become chafed and create a fire or other electrical hazards.

One Year Limited Warranty

Important: Evidence of original purchase is required for warranty service.

WARRANTOR: UNIDEN AMERICA CORPORATION ("Uniden")

ELEMENTS OF WARRANTY: Uniden warrants, for one year, to the original retail owner, this Uniden Product to be free from defects in materials and craftsmanship with only the limitations or exclusions set out below.

WARRANTY DURATION: This warranty to the original user shall terminate and be of no further effect 12 months after the date of original retail sale. The warranty is invalid if the Product is (A) damaged or not maintained as reasonable or necessary, (B) modified, altered, or used as part of any conversion kits, subassemblies, or any configurations not sold by Uniden, (C) improperly installed, (D) serviced or repaired by someone other than an authorized Uniden service center for a defect or malfunction covered by this warranty, (E) used in any conjunction with equipment or parts or as part of any system not manufactured by Uniden, or (F) installed or programmed by anyone other than as detailed by the owner's manual for this product.

STATEMENT OF REMEDY: In the event that the product does not conform to this warranty at any time while this warranty is in effect, warrantor will either, at its option, repair or replace the defective unit and return it to you without charge for parts, service, or any other cost (except shipping and handling) incurred by warrantor or its representatives in connection with the performance of this warranty. Warrantor, at its option, may replace the unit with a new or refurbished unit. **THE LIMITED WARRANTY SET FORTH ABOVE IS THE SOLE AND ENTIRE WARRANTY PERTAINING TO THE PRODUCT AND IS IN LIEU OF AND EXCLUDES ALL OTHER WARRANTIES OF ANY NATURE WHATSOEVER, WHETHER EXPRESS, IMPLIED OR ARISING BY OPERATION OF LAW, INCLUDING, BUT NOT LIMITED TO ANY IMPLIED WARRANTIES OF MERCHANTABILITY OR FITNESS FOR A PARTICULAR PURPOSE. THIS WARRANTY DOES NOT COVER OR PROVIDE FOR THE REIMBURSEMENT OR PAYMENT OF INCIDENTAL OR CONSEQUENTIAL DAMAGES.** Some states do not allow this exclusion or limitation of incidental or consequential damages so the above limitation or exclusion may not apply to you.

LEGAL REMEDIES: This warranty gives you specific legal rights, and you may also have other rights which vary from state to state. This warranty is void outside the United States of America and Canada.

PROCEDURE FOR OBTAINING PERFORMANCE OF WARRANTY: If, after following the instructions in the owner's manual you are certain that the Product is defective, pack the Product carefully (preferably in its original packaging). The Product should include all parts and accessories originally packaged with the Product. Include evidence of original purchase and a note describing the defect that has caused you to return it. The Product should be shipped freight prepaid, by traceable means, to warrantor at:

Uniden America Corporation
Parts and Service Division

4700 Amon Carter Blvd. Fort Worth, TX 76155
(800) 297-1023, 8 a.m. to 5 p.m. CST, Monday through Friday

Industrial Canada Information

TERMINAL EQUIPMENT

NOTICE: This equipment meets the applicable Industry Canada Terminal Equipment Technical Specifications. This is confirmed by the registration number. The abbreviation, IC, before the registration number signifies that registration was performed based on a Declaration of Conformity indicating that Industry Canada technical specifications were met. It does not imply that Industry Canada approved the equipment.

NOTICE: The Ringer Equivalence Number (REN) for this terminal equipment is marked on the equipment itself. The REN assigned to each terminal equipment provides an indication of the maximum number of terminals allowed to be connected to a telephone interface. The termination on an interface may consist of any combination of devices subject only to the requirement that the sum of the Ringer Equivalence Numbers of all the devices does not exceed five.

RADIO EQUIPMENT

The term “IC:” before the radio certification number only signifies that Industrial Canada technical specifications were met.

Operation is subject to the following two conditions: (1) this device may not cause interference, and (2) this device must accept any interference, including interference that may cause undesired operation of the device. “Privacy of communications may not be ensured when using this telephone”.

Index

0 - 9

- 2-line features
 - 2-line operation26
 - 3-way conferencing27
 - 4-way conferencing28
 - Transferring calls30
 - Using the speakerphone30
 - Using your EXI3226 intercom29

A

- Answering a call.....23
- Area code17

B

- Battery pack
 - Install the battery pack9
 - Replacement and handling47

C

- Caller ID features
 - Deleting a Caller ID message43
 - Deleting all Caller ID name/numbers44
 - Storing a Caller ID number in a memory location42
 - Using CIDCW (Caller ID on Call Waiting).....44
 - Using the Caller ID list41
 - Viewing the Caller ID message list..40
- Connect the base unit11

D

- Dialing mode16
- Digital security code45

E, F, G

- Earpiece volume20
- Flash and call waiting22

H

- Headset installation46

I, J, K, L

- Installing the beltclip46

M, N

- Maintenance47
- Making a call.....24
- Making and receiving calls19
- Memory features
 - Editing a stored name and/or phone number35
 - Erasing a stored name and phone number37
 - Making calls
 - with memory dialing.....34
 - Storing phone numbers and names31
- Mounting the base unit on a wall13

O

- Out-of-range21

P, Q

- Page feature22
- Placing a Call on Hold25

R

- Redial21
- Ringer volume20

S

- Selecting a Different Channel22
- Setting menu options15
- Setting the language18
- Setup
 - Base unit11
 - Handset.....9
- Speaker volume20
- Specifications50

T

- Tone dialing switch-over21
- Troubleshooting48

U, V, W, X, Y, Z

- Using the speakerphone mute feature25

At Uniden, we'll take care of you!

If you need any assistance with this product, please call our Customer Hotline at

1-800-297-1023

PLEASE DO NOT RETURN THIS PRODUCT TO THE PLACE OF PURCHASE.

Our Uniden representatives will be happy to help you with any matters regarding the operation of this unit, available accessories, or any other related matters.

Thank you for purchasing a Uniden product.

Hours: M-F 8:00 AM to 5:00 PM CST.



For information on the accessibility features of this product, please call

1-800-874-9314 (V/TTY)

Uniden®

Uniden®

May be covered under one or more of the following U.S. patents:

4,523,058	4,595,795	4,797,916	5,381,460	5,426,690	5,434,905
5,491,745	5,493,605	5,533,010	5,574,727	5,581,598	5,650,790
5,660,269	5,661,780	5,663,981	5,671,248	5,696,471	5,717,312
5,732,355	5,754,407	5,758,289	5,768,345	5,787,356	5,794,152
5,801,466	5,825,161	5,864,619	5,893,034	5,912,968	5,915,227
5,929,598	5,930,720	5,960,358	5,987,330	6,044,281	6,070,082
6,125,277	6,253,088	6,314,278			

©2003 Uniden America Corporation, Fort Worth, Texas
Custom manufactured in China.

Contains additional foreign articles.
UPZZ01006BZ